

Addressable Devices Wiring Diagram

(2017~2018)

Addressable Fire Alarm system Wiring Diagram

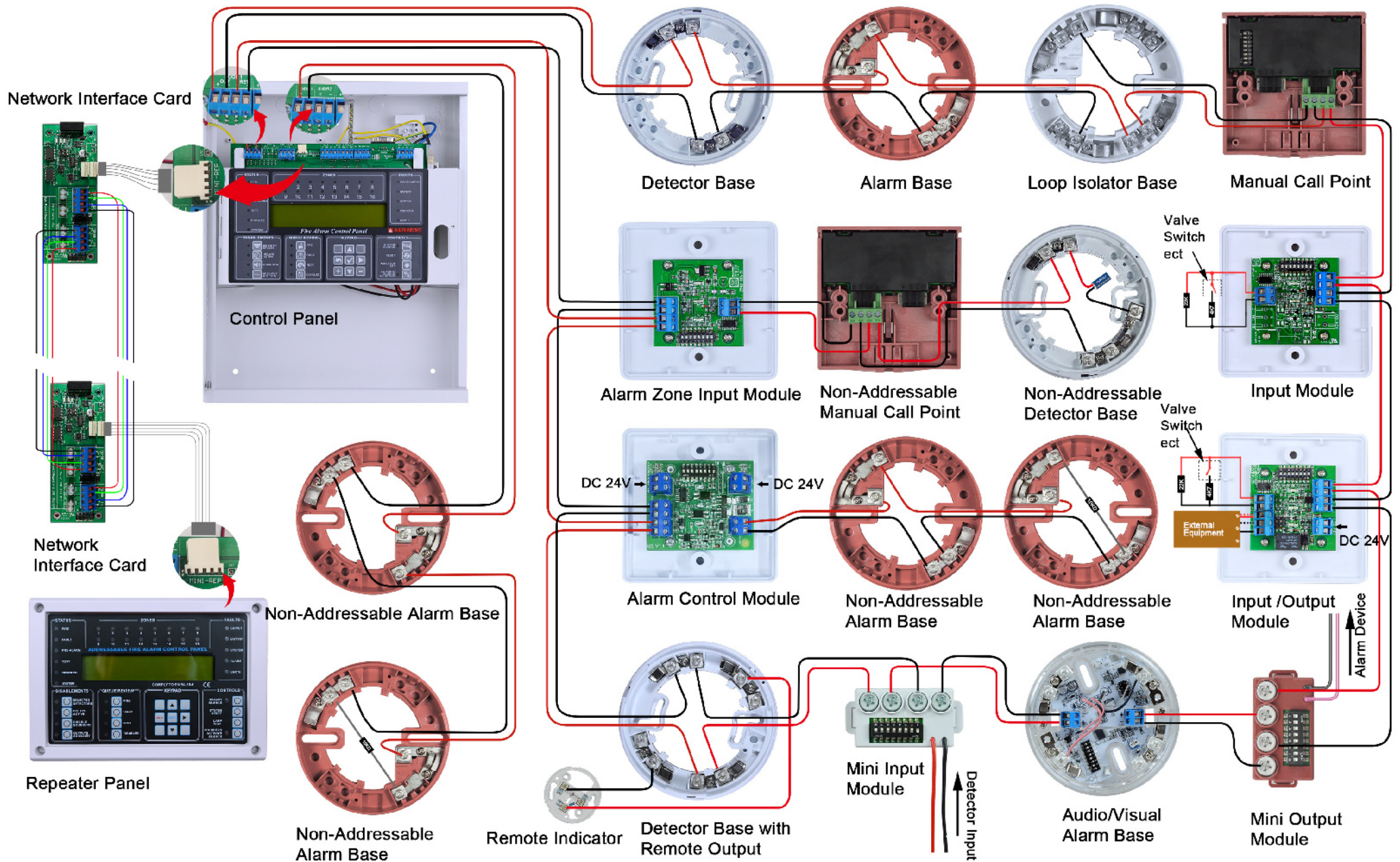

CN302A/481-001 Base Wiring Diagram

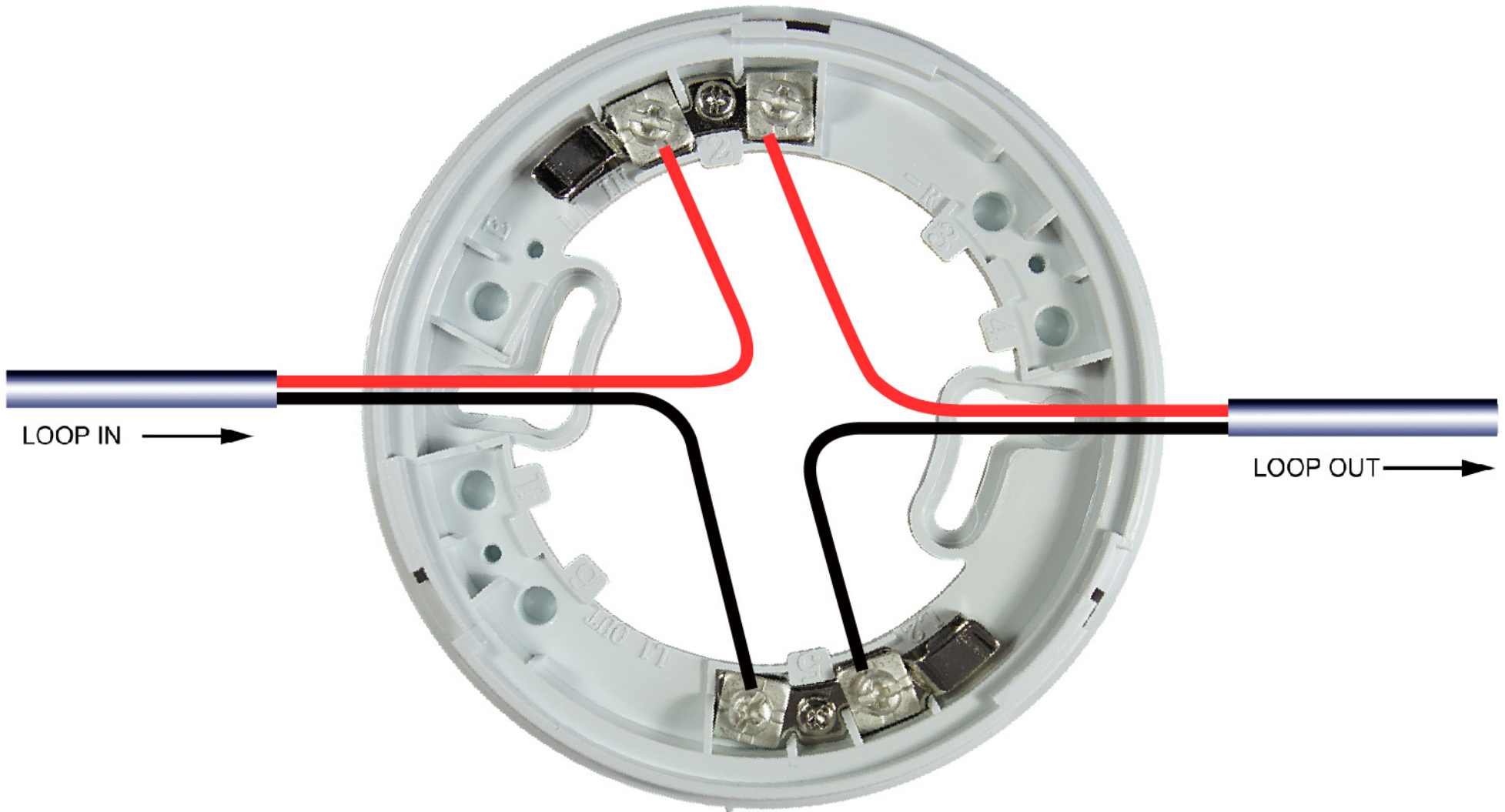

CN304A/481-003 Base Wiring Diagram

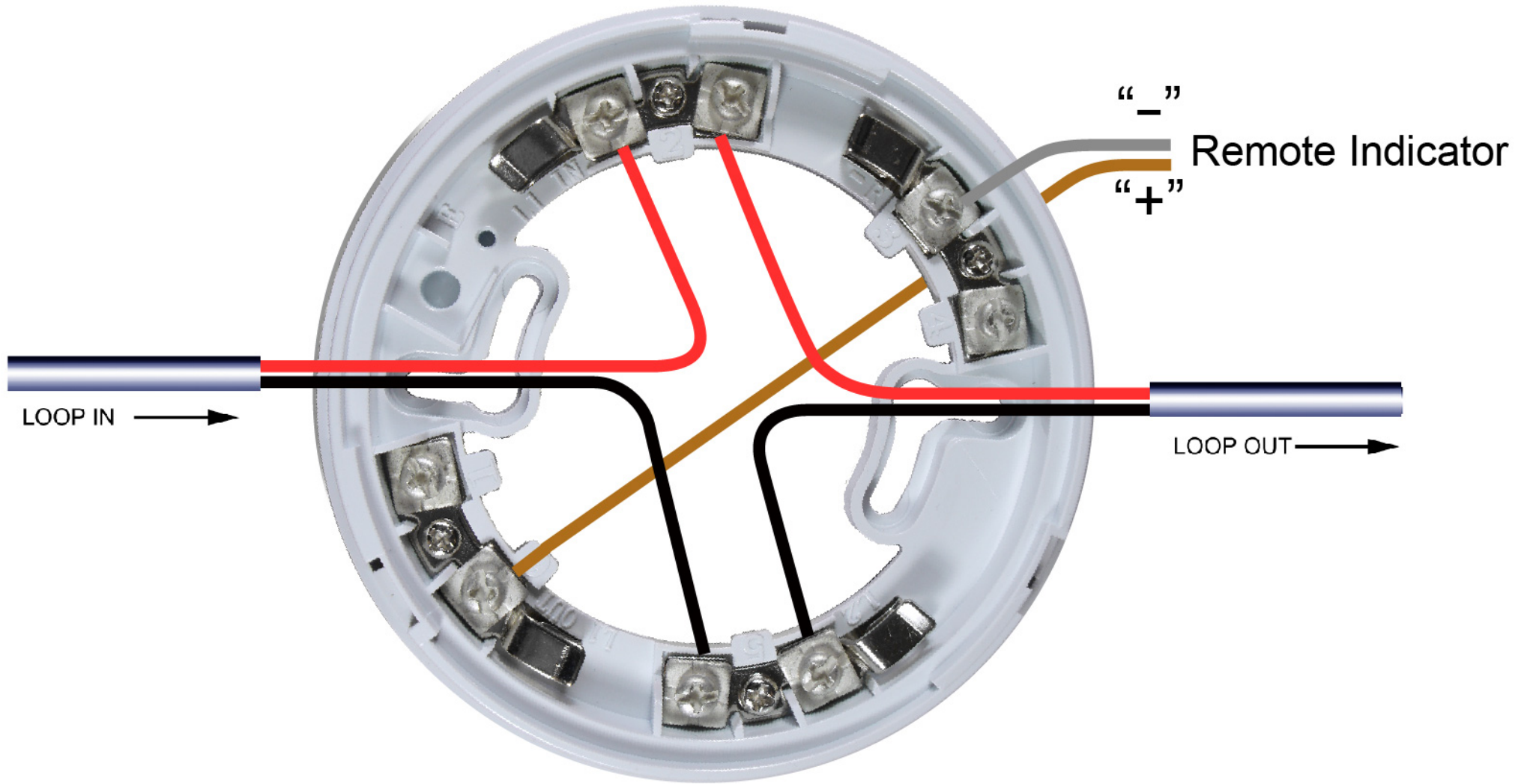

682-004 Isolator Base Wiring Diagram

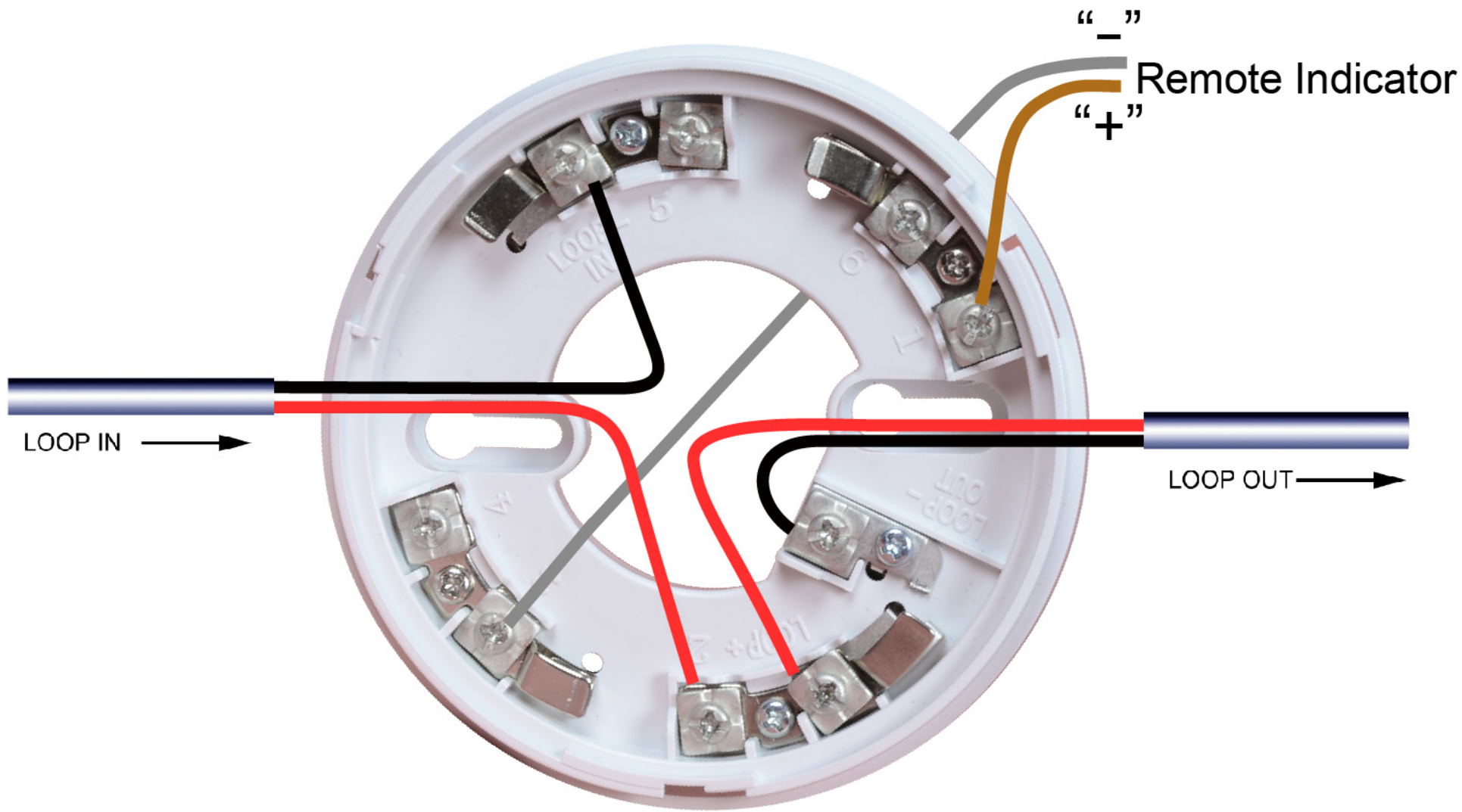

682-003 Isolator Base Wiring Diagram

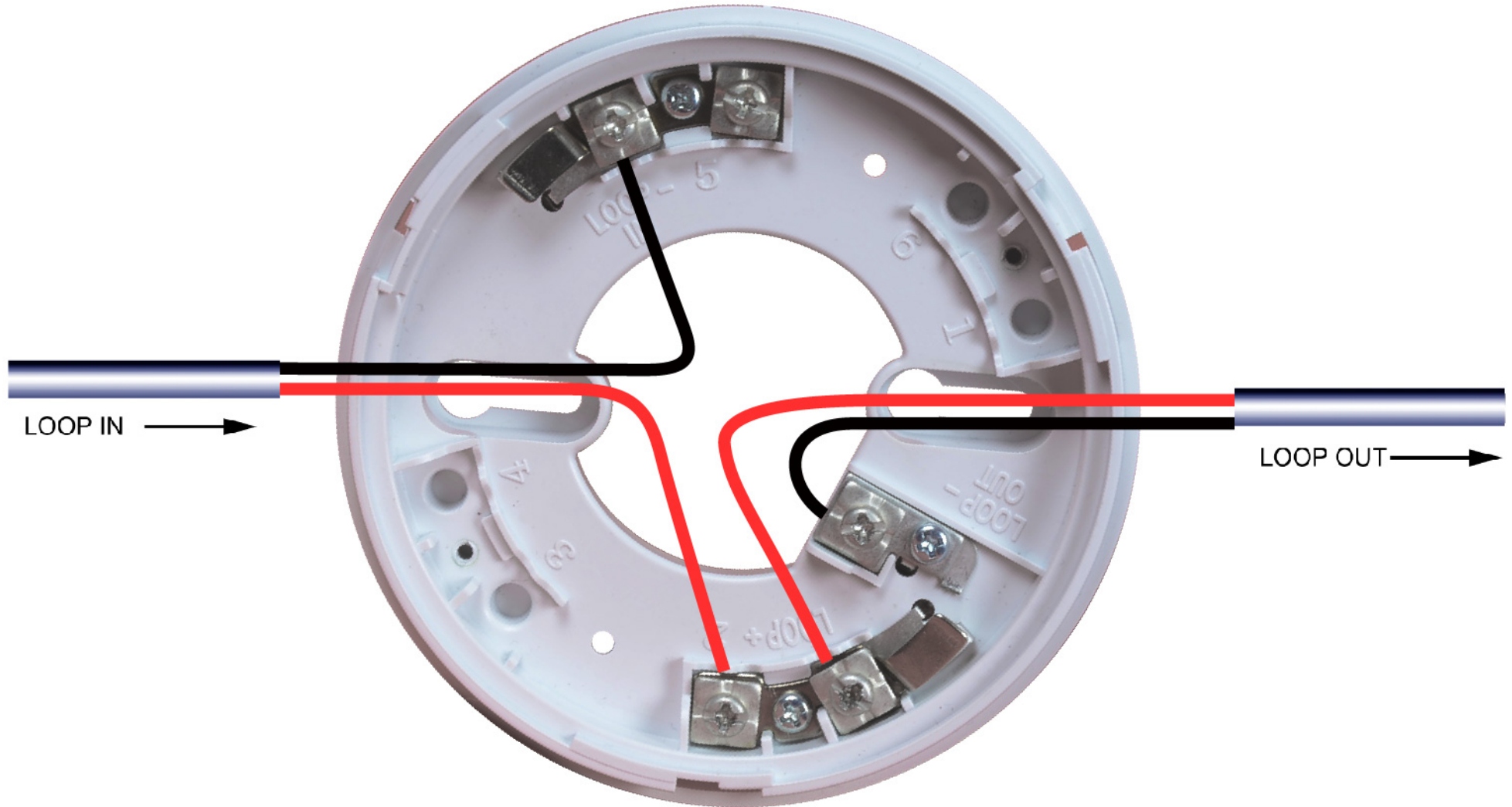

660 Manual Call Point Wiring Diagram

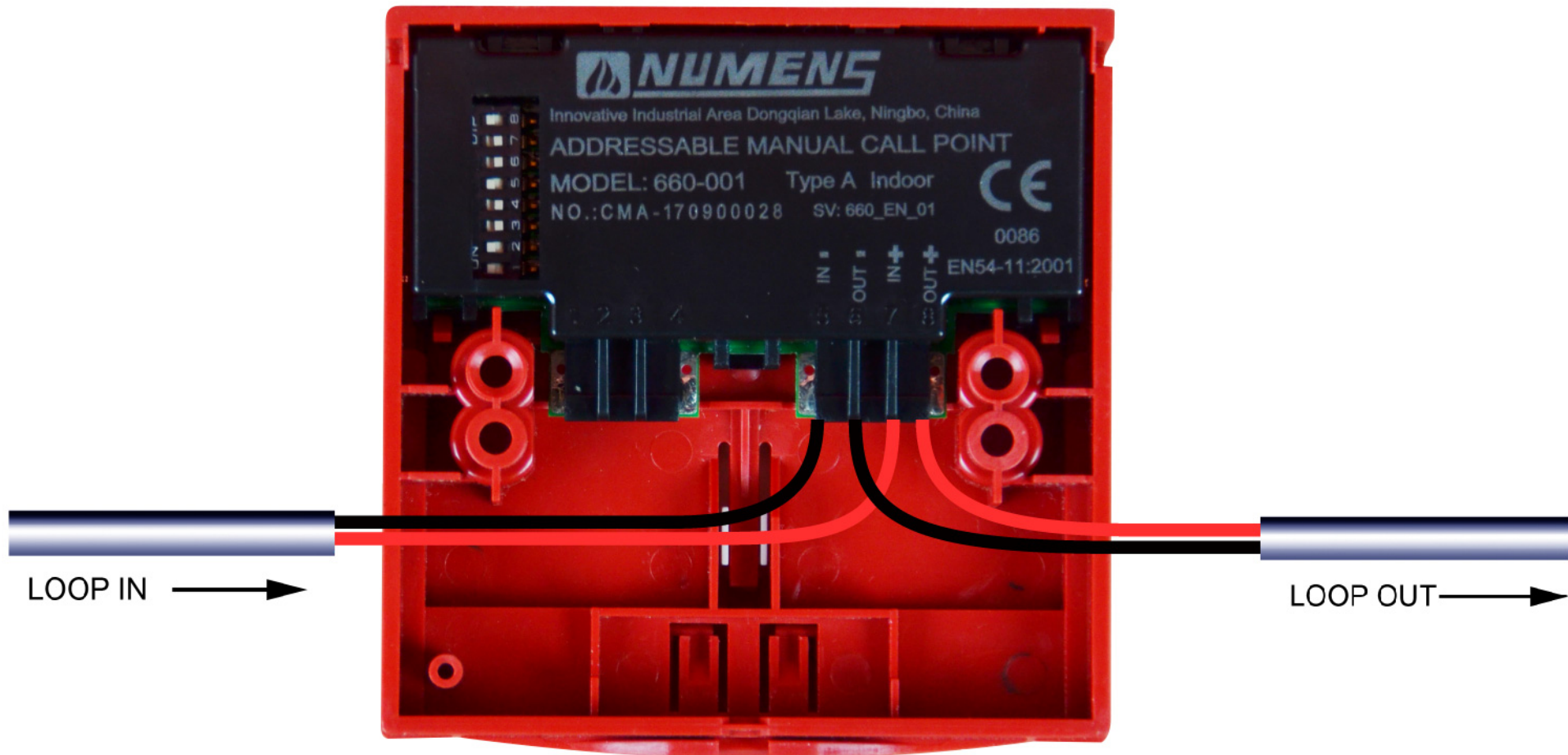

640 Audio/Visual Alarm Device Wiring Diagram

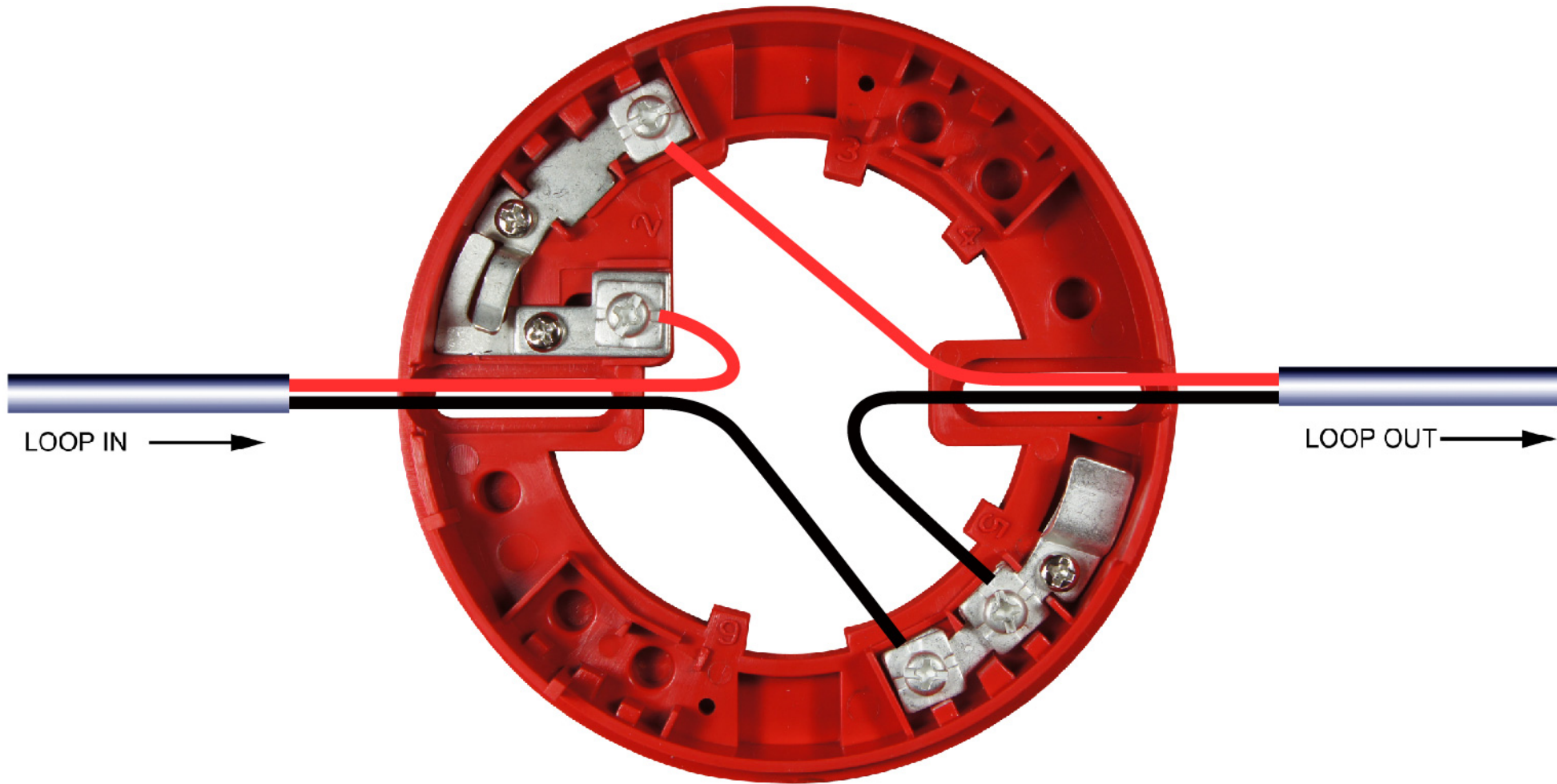

683 Audio/Visual Alarm Base Wiring Diagram

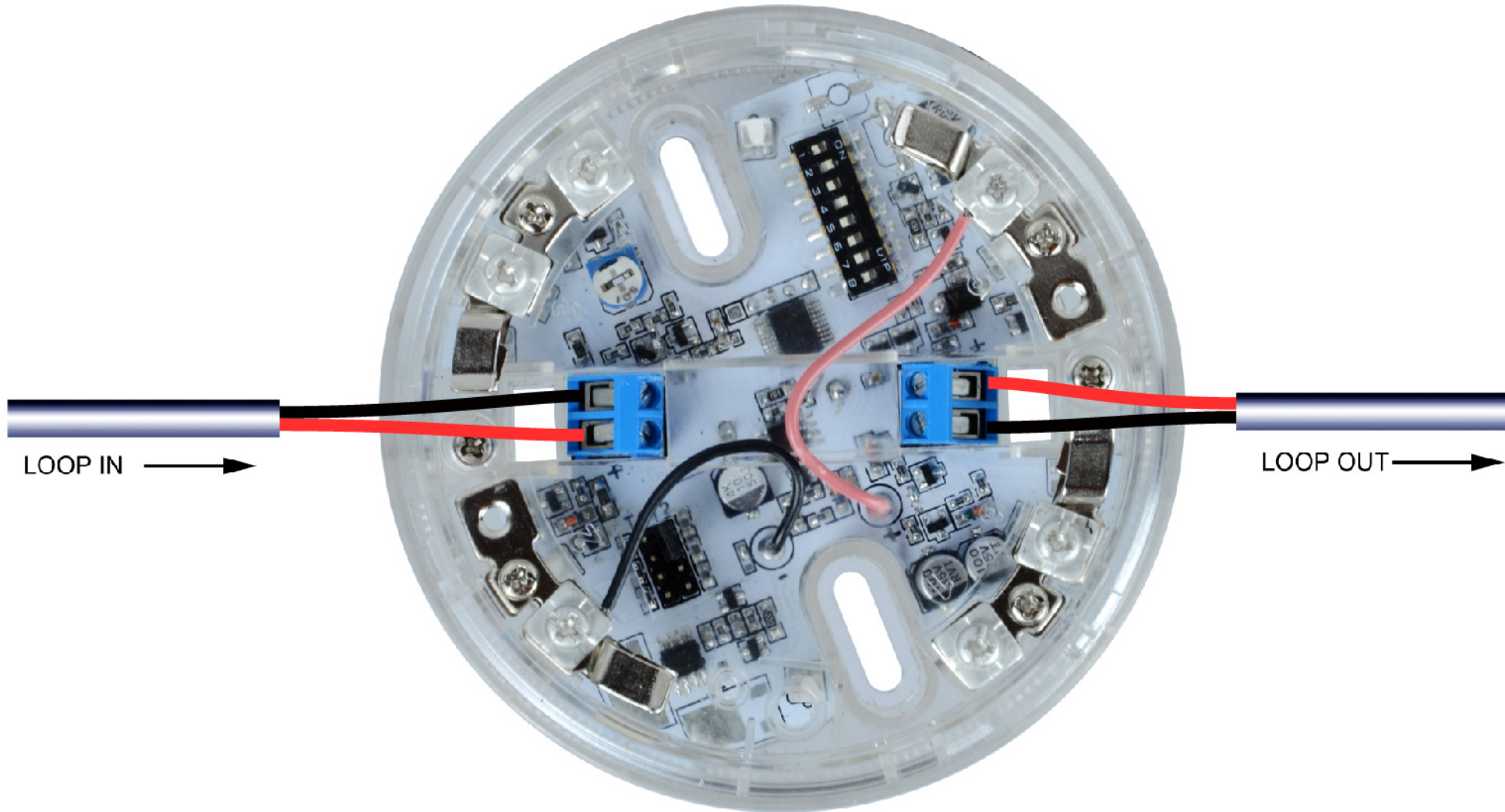

680 Loop Isolator Wiring Diagram

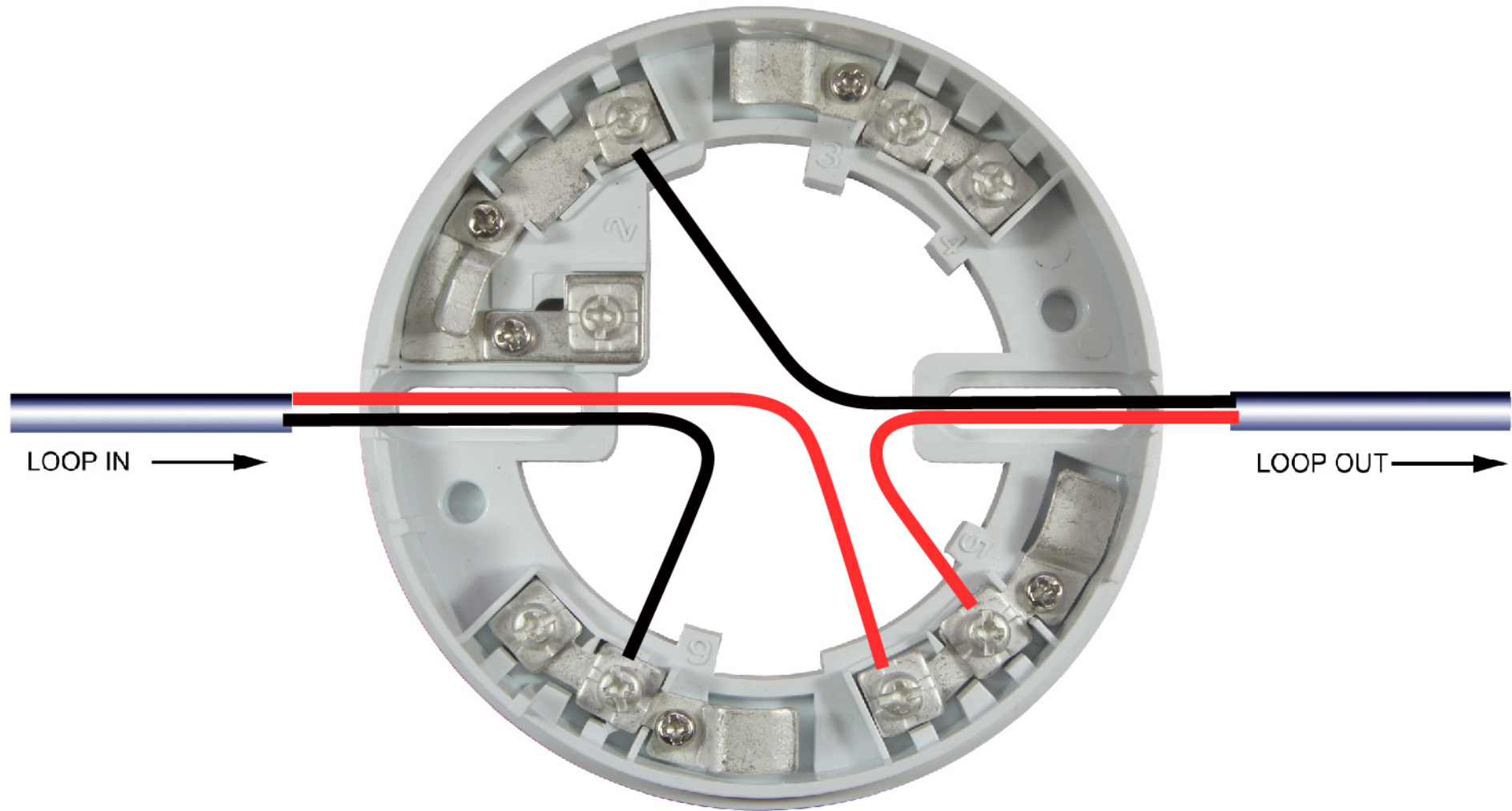

681 Remote Indicator Wiring Diagram

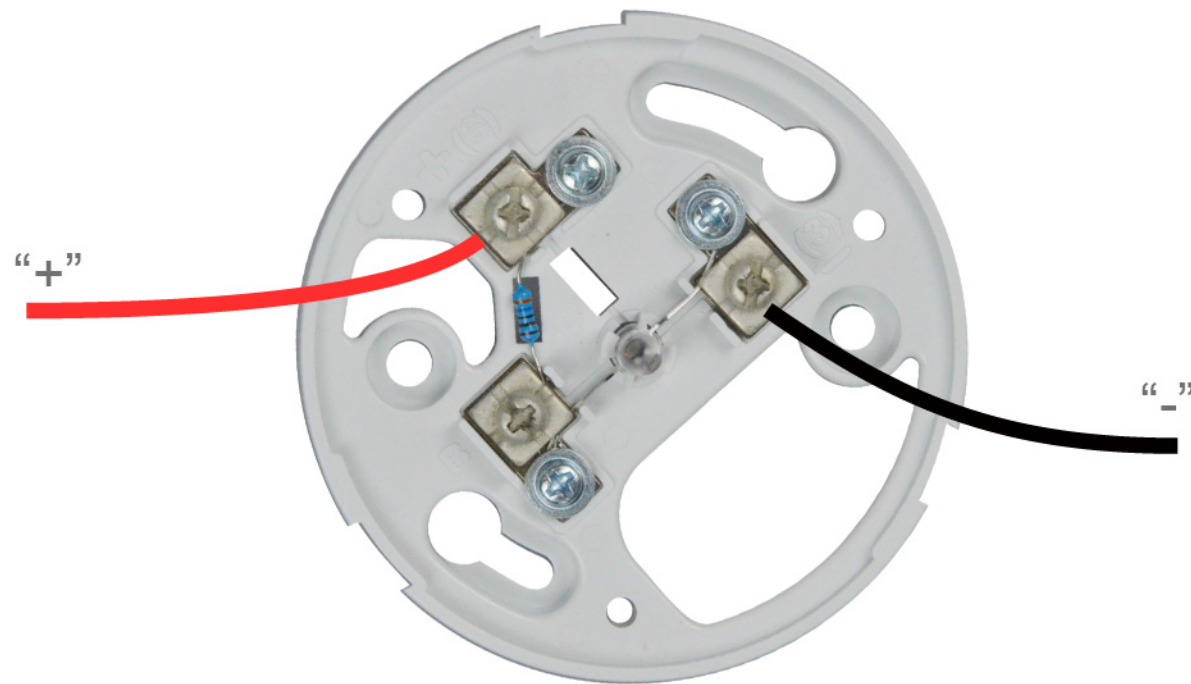

620 Mini Input Module Wiring Diagram

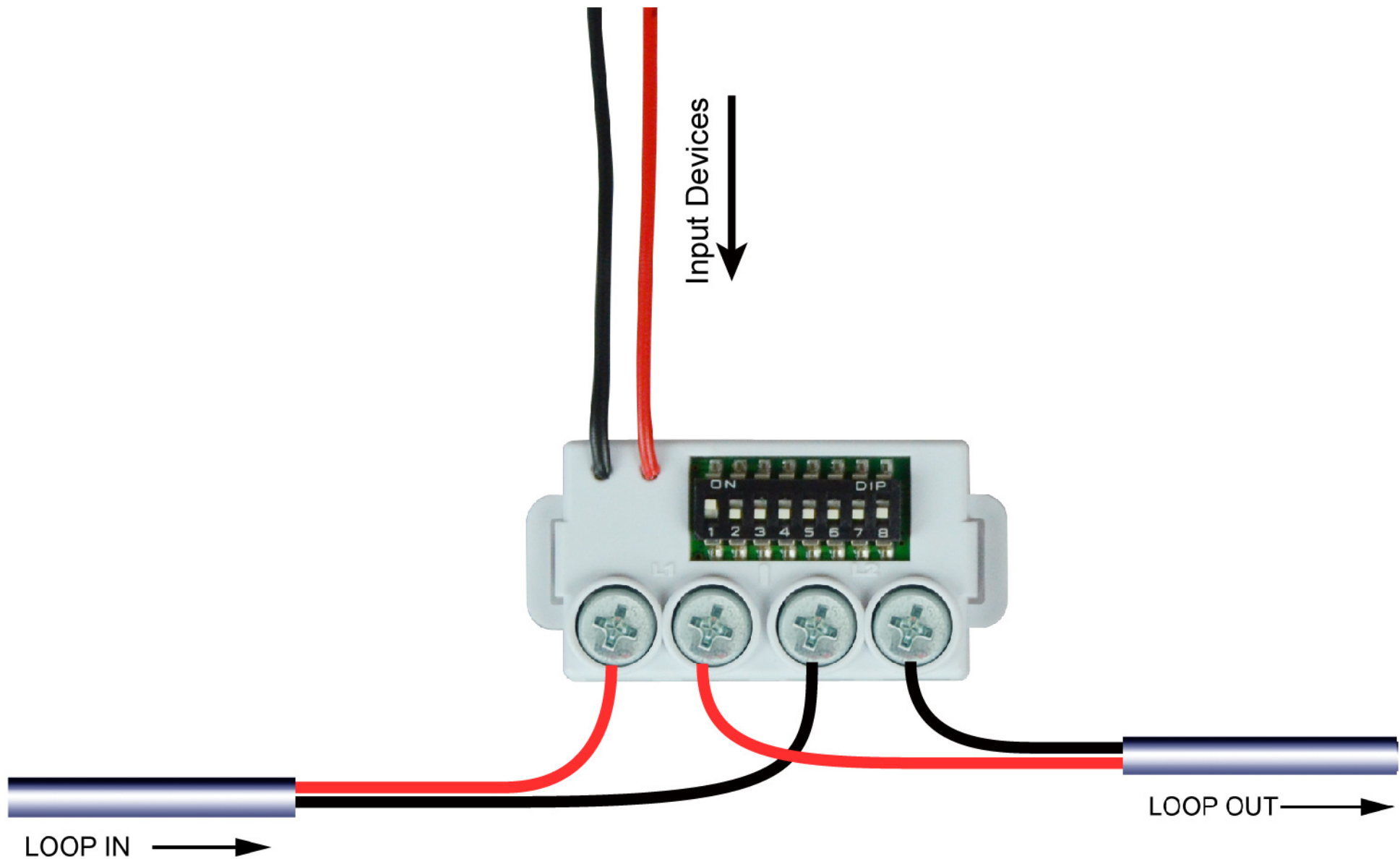

620 Mini Output Module Wiring Diagram

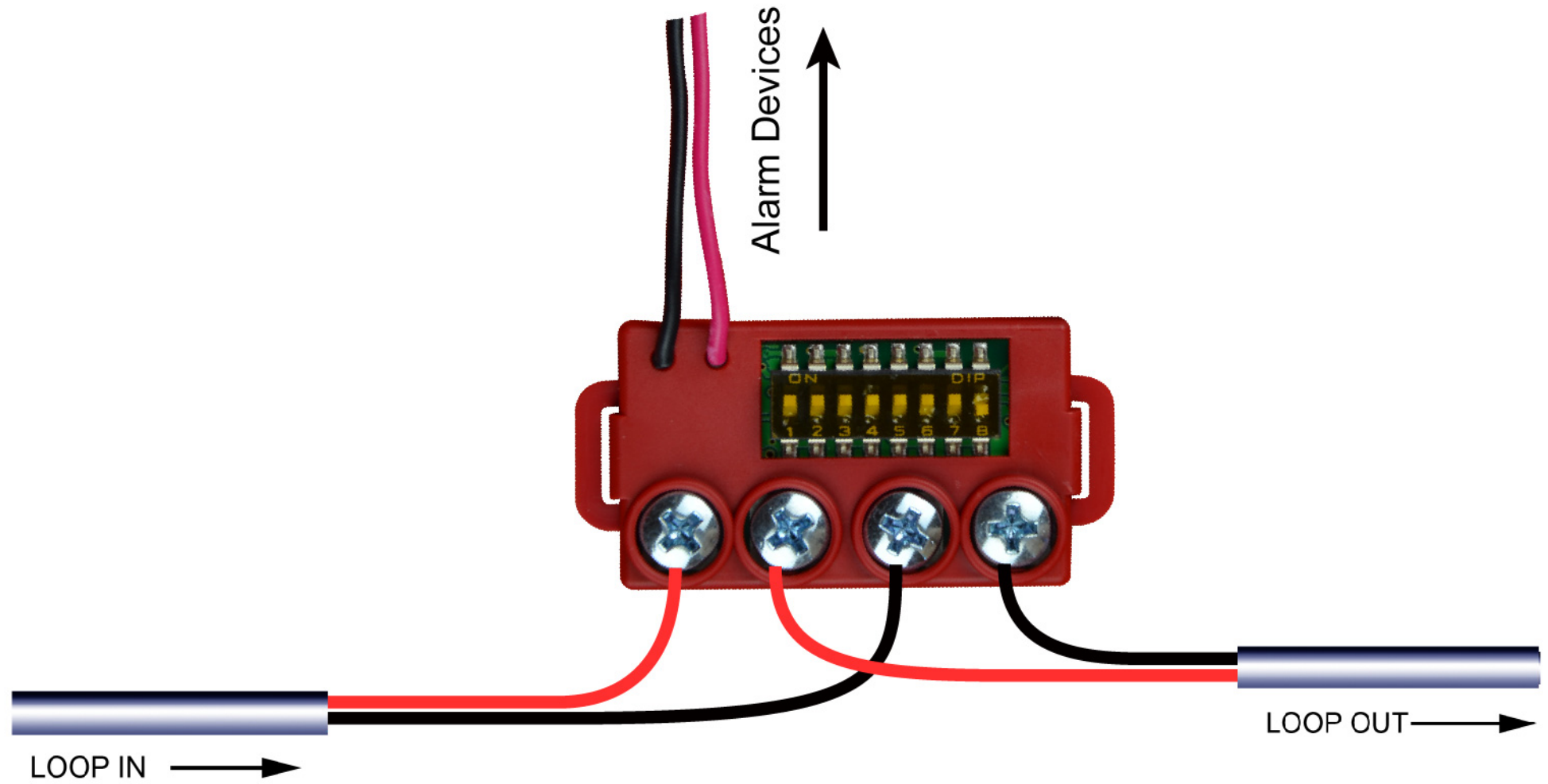

621 Input/Output Module Wiring Diagram

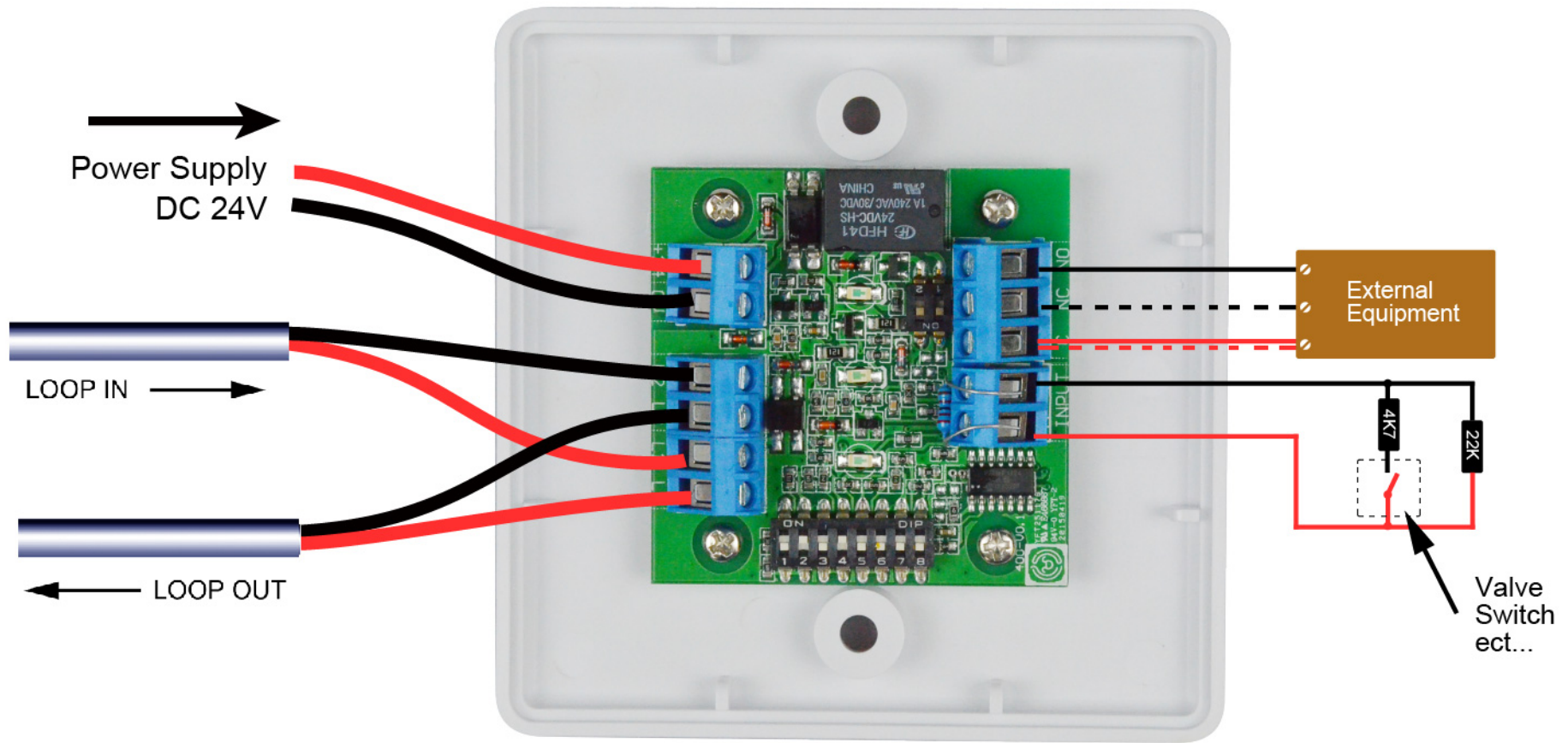

621 Alarm Zone Input Module Wiring Diagram

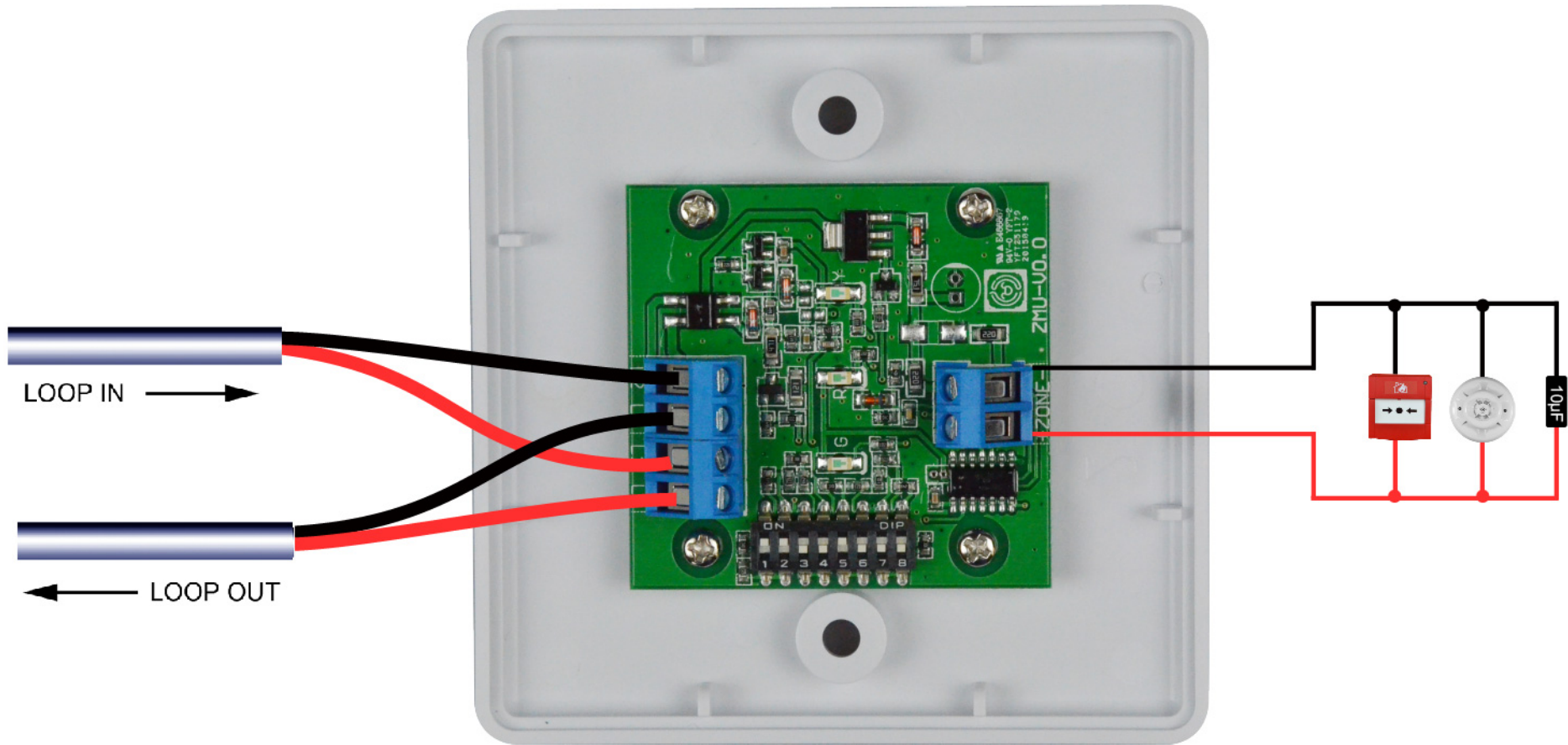

621 Input Module Wiring Diagram

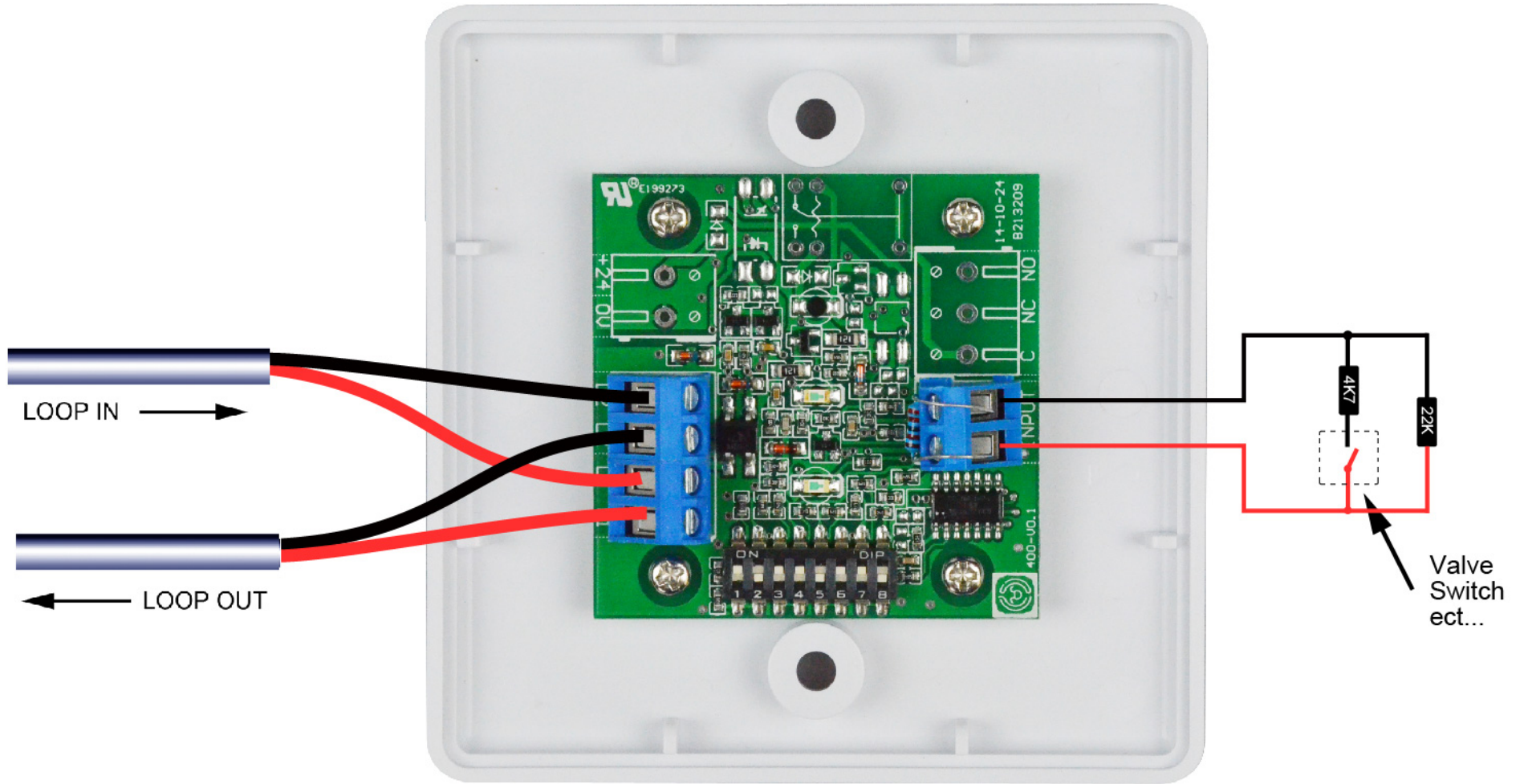

622 Alarm Control Module Wiring Diagram

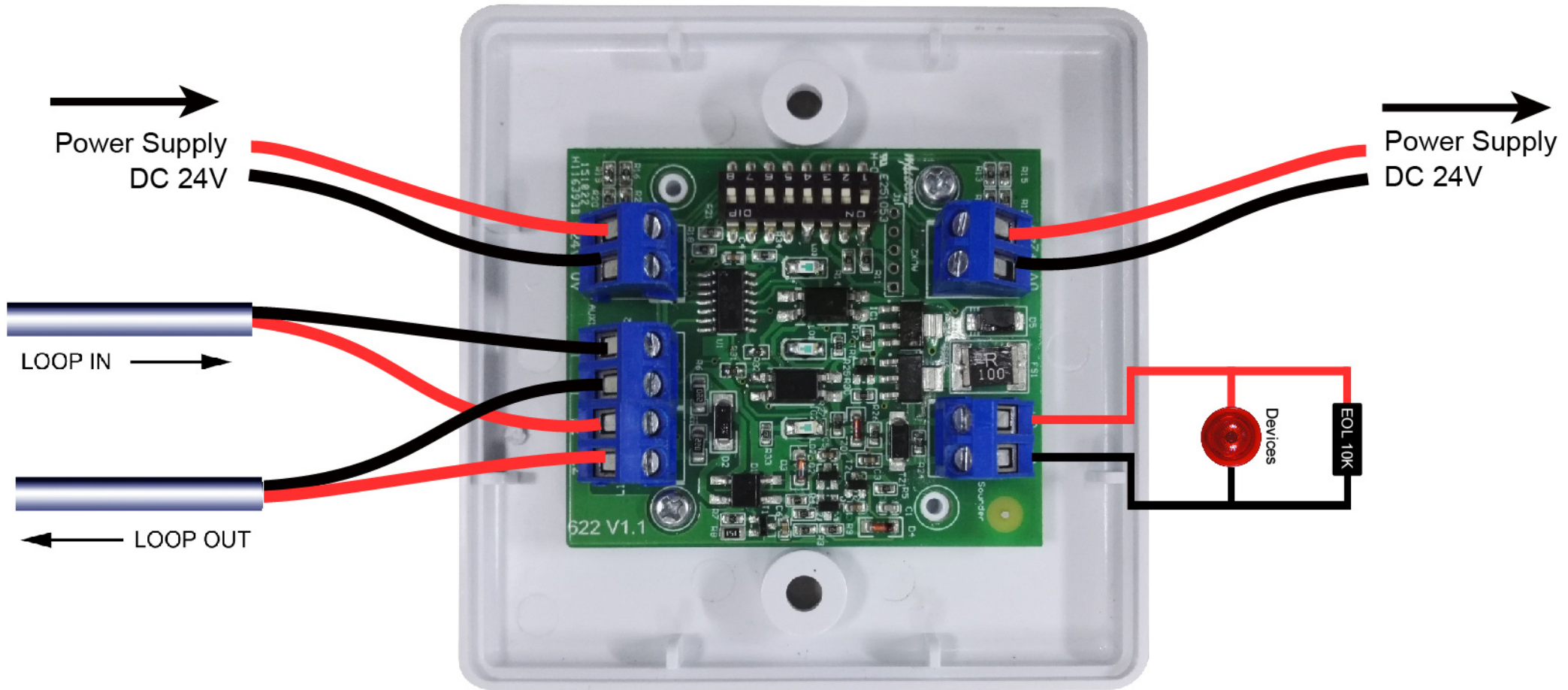

6001-04 Remote LED Display Card Wiring Diagram

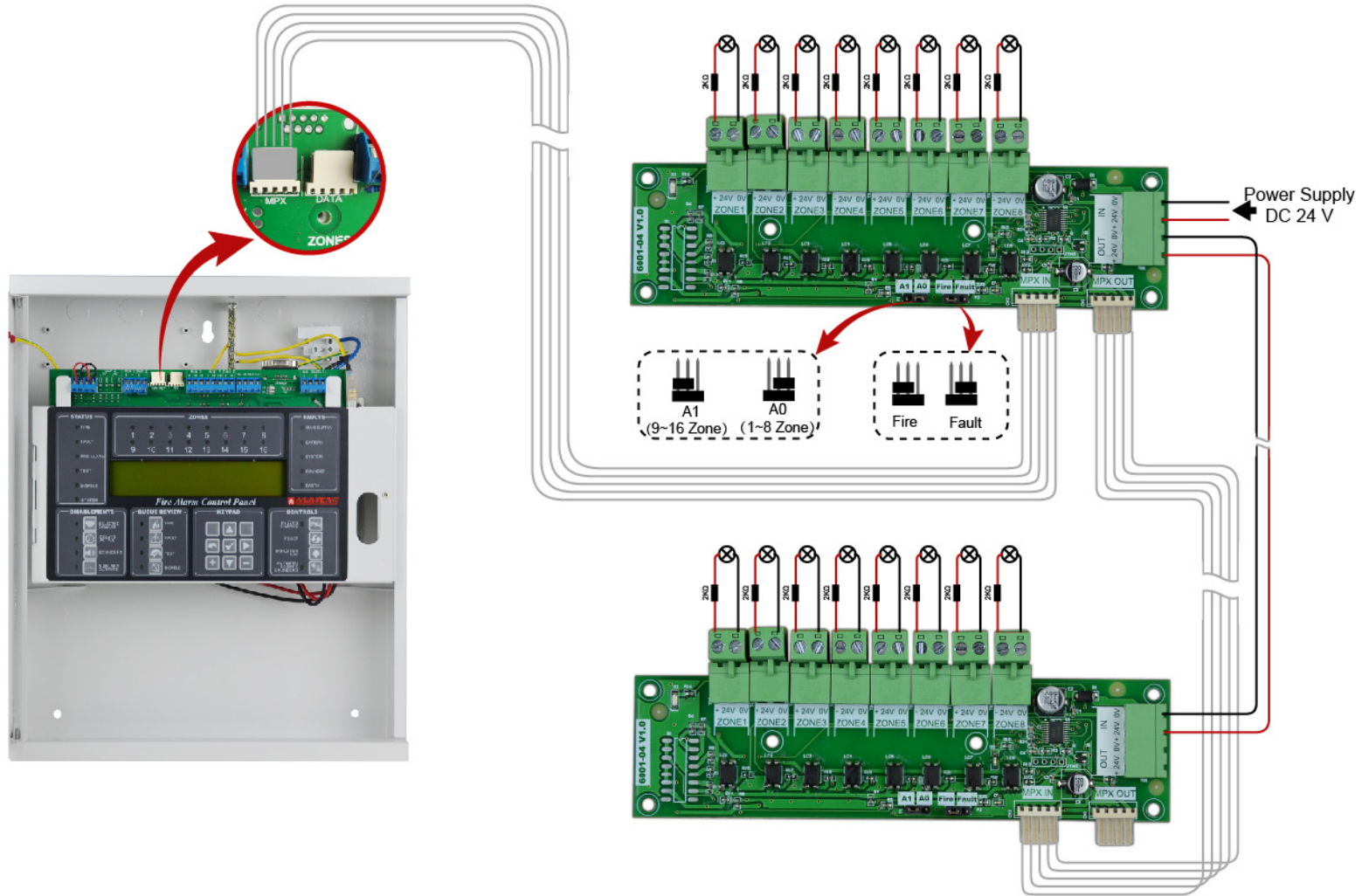

6001-07 Detection Zone Output Card Wiring Diagram

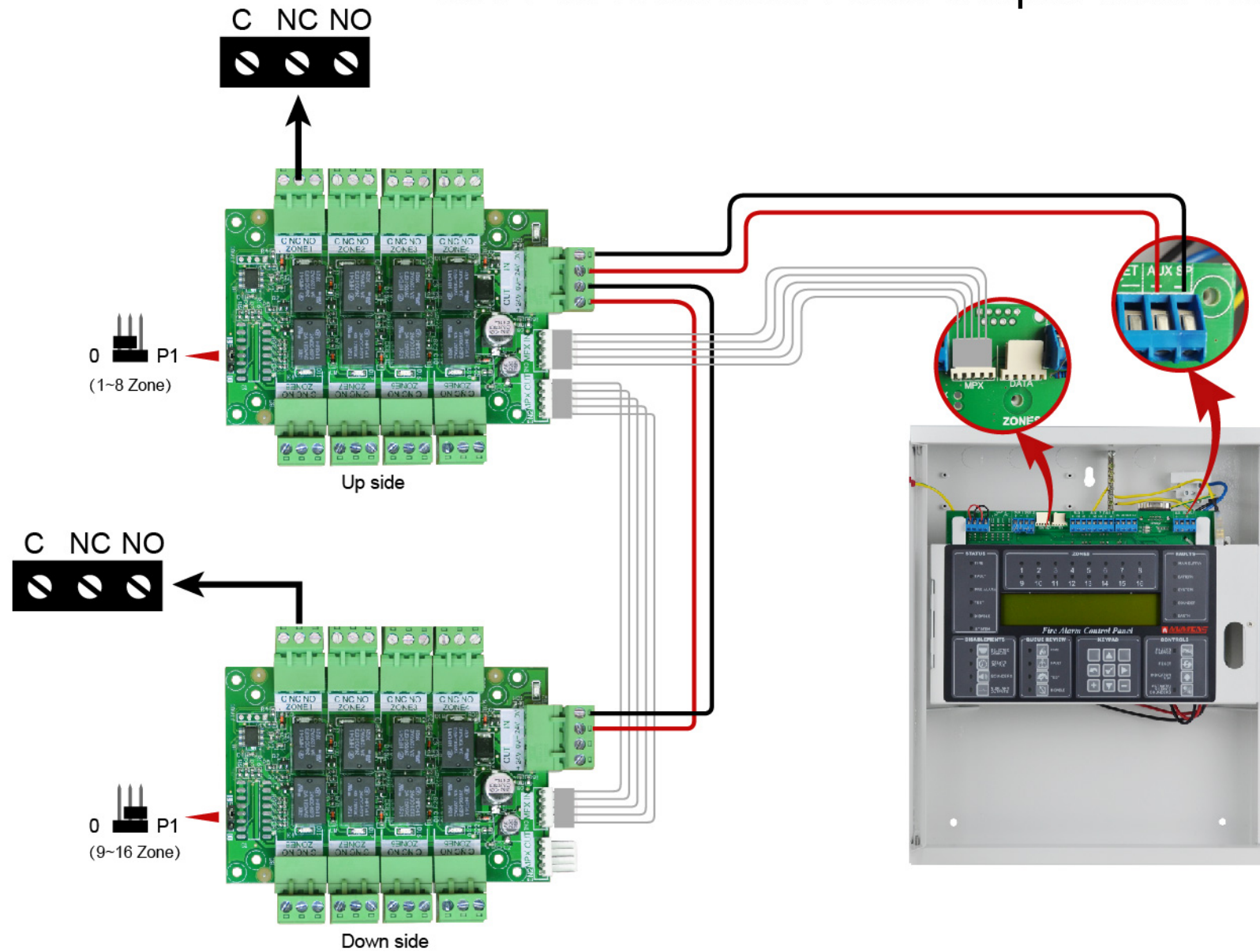

6002-03 Loop Expansion Panel Wiring Diagram

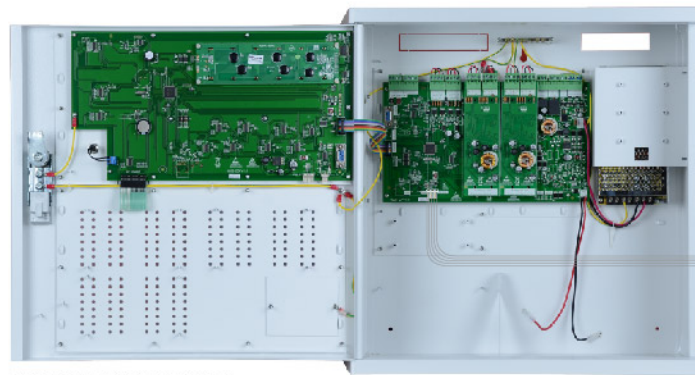

6002-01 Control Panel

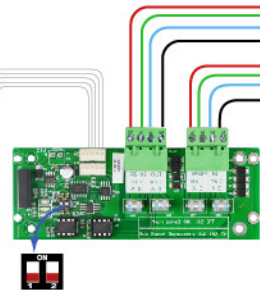

6001-03 Network Interface Card

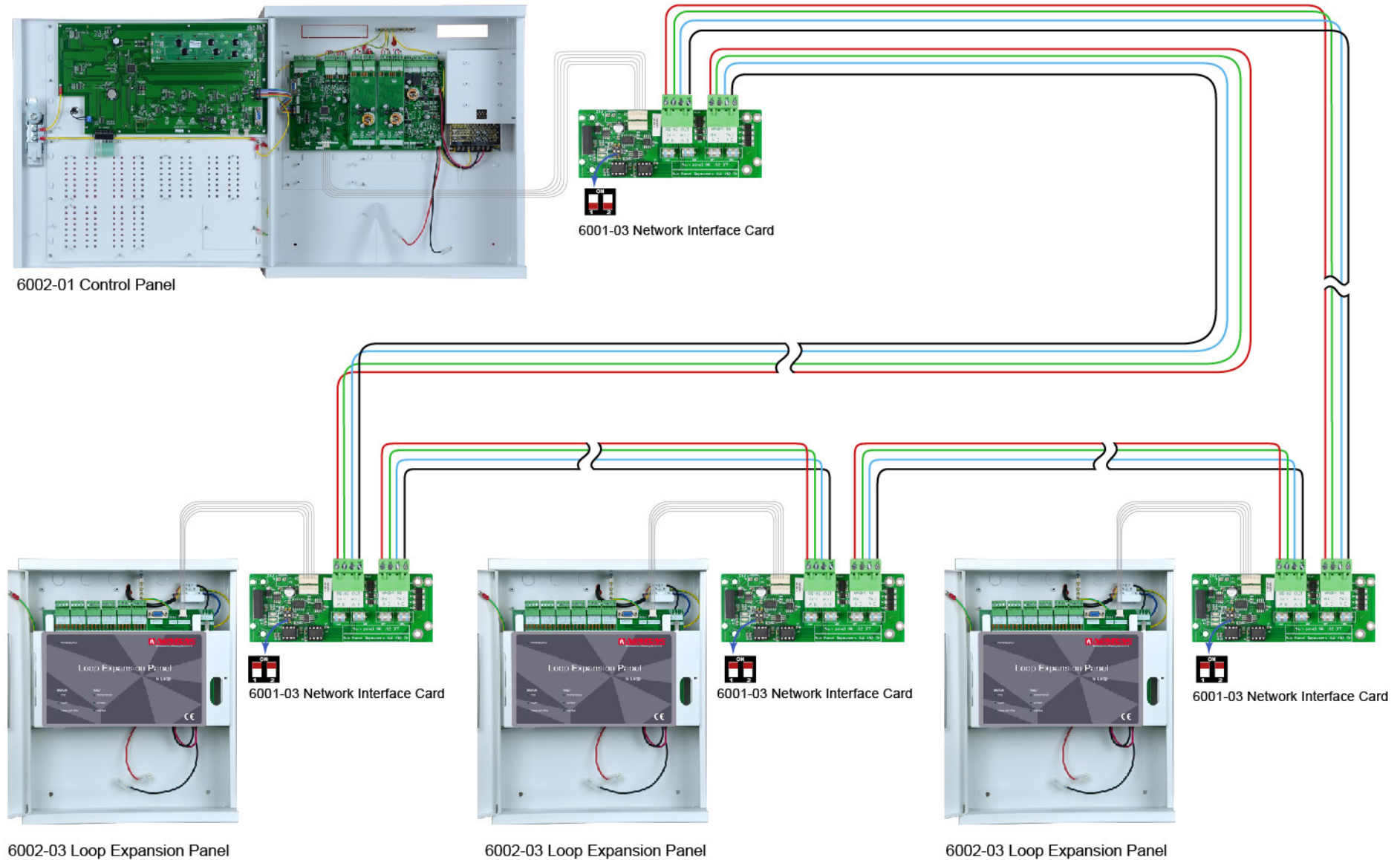

6002-03 Loop Expansion Panel

6002-03 Loop Expansion Panel

6002-03 Loop Expansion Panel